

Pillar Light with Motion Sensor



18x SMD LED
(Cool White)
@ 0.2wea



1x SMD LED
(Warm White)
@ 0.2wea



1x 3.6V
2.3Ah NiMH



2.4W Integrated
Polycrystalline



Dust & Water
Protection



Aluminium Alloy
Construction



200 Lumens
at 1 metre



SLDPIL0009A-3.8W-PIR

Features:

- Pyro-electric Infrared Sensor
- Manual Over-Ride on Sensor
- Built in Photo Electric Cell
- 1minute Sensor Run Time
- 6-8 hours Operation per day
- Surface Mounted Base
- Black P.C. Finish
- Glass Lampshade
- **1 Year Warranty!**

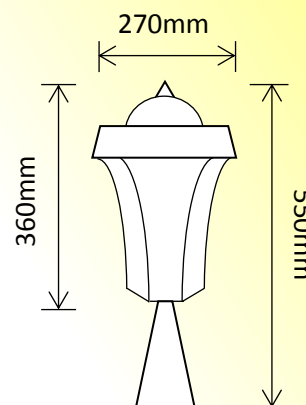

SLDPIL0012A-3.8W-PIR

Features:

- Pyro-electric Infrared Sensor
- Manual Over-Ride on Sensor
- Built in Photo Electric Cell
- 1minute Sensor Run Time
- 6-8 hours Operation per day
- Surface Mounted Base
- Black P.C. Finish
- Glass Lampshade
- **1 Year Warranty!**

