

Neon Flex

- 
IP68
INGRESS PROTECTION
- 
3y
YEARS WARRANTY
- 
SALTWATER RESISTANT
- 
SOLVENT RESISTANT
- 
ULTRA VIOLET PROTECTION
- 
3s
STEP MACADAM
- 
YES
HORIZONTAL BENDING
- 
LM80
LUMEN MAINTENANCE
- 
24V DC
OBSERVE POLARITY

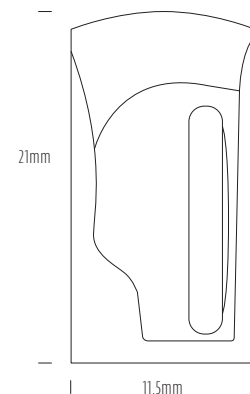
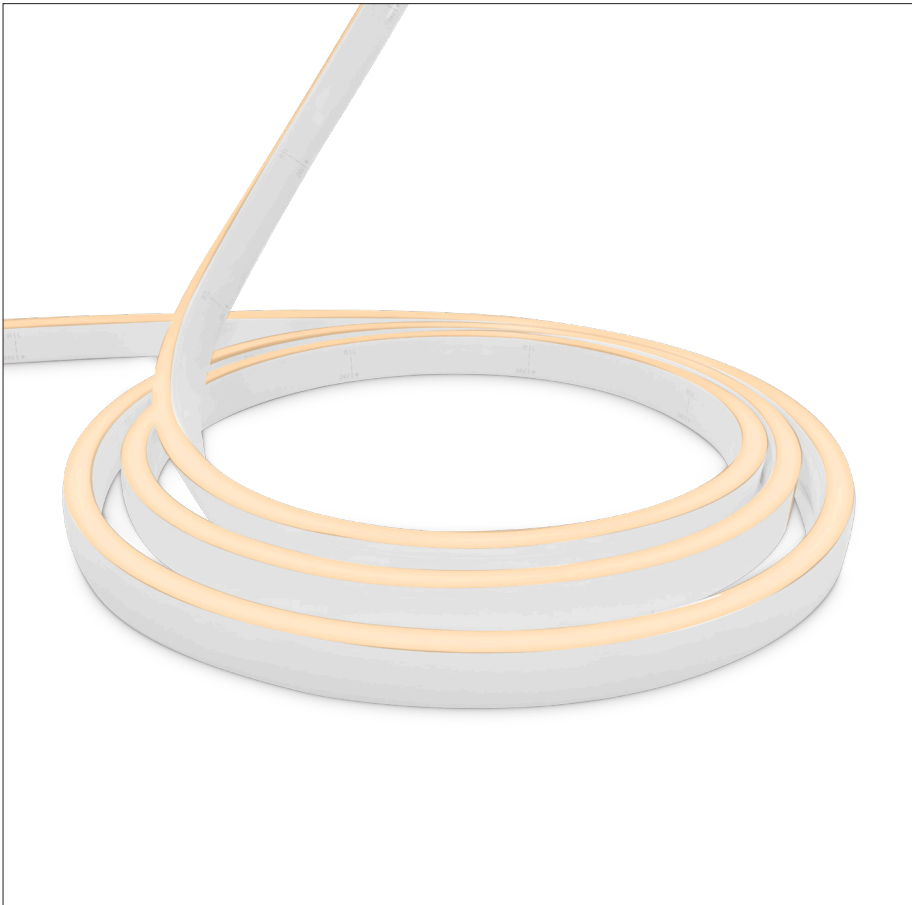

Product	AQS-500-Mono
Voltage	24V DC
Watts (per Meter)	5W / 12W / 8W
IP Rating	IP68
Lumen Output (per Meter)	See Page 2
CCT & Colour Options	2200K to 6500K / Colours
Working Mode	Constant Voltage (PWM) / DMX
Max Length (Single Power Feed)	15m (5W / 8W) / 10m (12W)
Max Length (Double Power Feed)	30m (5W / 8W) / 20m (12W)
Cut Interval	167mm (5W / 8W) / 100mm (12W)
Bend Direction	Horizontally
Minimum Bend Diameter	120mm
LED Type	SMD 3528 (5W) / SMD5050 (12W / 8W)
LED Qty / M	72pcs (5W) / 60pcs (12W / 8W)
Lumen Maintenance	70,000 Hours L70@ 25°C, 50,000 Hours L70@ 50°C
Materials	Eco PVC
Emission Angle	120°
Operating Temperature	-20° to +40°C
Installation Temperature	5° to +35°C
Warranty	3 Year Aqualux Warranty

Production Tolerances

The AQS-500 series Neon Flex product is manufactured in a continuous extrusion process and then manually terminated with IP68 overmolded cable entry points. Production tolerances need to be accounted for during site preparation.

- < 1M ±5mm
- < 5M Length ±10mm
- < 10M Length ±15mm
- < 20M ± 20mm

Refer to installation guide when planning your project.

Dimming Options

PSU Control (1-10V / PWM / Phase / Remote)
24V Control (PWM)

For wiring diagrams please refer to the aqualux website: www.aqualux.com.au / Support / Downloads / Wiring Diagrams

1300 662 644
sales@aqualux.com.au



Neon Flex

Variations

Product Code	CCT Kelvin	Voltage Direct Current	Watts Meter	Lumens Meter	Min Run Single End	Max Run Double End
AQS-500-RDA08	RED	24V DC	08W	110lm	15m	30m
AQS-500-ORA08	ORANGE	24V DC	08W	90lm	15m	30m
AQS-500-AMA08	AMBER	24V DC	08W	100lm	15m	30m
AQS-500-GNA12	GREEN	24V DC	12W	200lm	10m	20m
AQS-500-BUA12	BLUE	24V DC	12W	35lm	10m	20m
AQS-500-LYA12	LEMON YELLOW	24V DC	12W	250lm	10m	20m
AQS-500-PKA12	PINK	24V DC	12W	150lm	10m	20m
AQS-500-22A12	2200K	24V DC	12W	280lm	10m	20m
AQS-500-25A12	2500K	24V DC	12W	280lm	10m	20m
AQS-500-27A12	2700K	24V DC	12W	280lm	10m	20m
AQS-500-30A12	3000K	24V DC	12W	280lm	10m	20m
AQS-500-35A12	3500K	24V DC	12W	330lm	10m	20m
AQS-500-40A12	4000K	24V DC	12W	330lm	10m	20m
AQS-500-50A12	5000K	24V DC	12W	350lm	10m	20m
AQS-500-57A12	5700K	24V DC	12W	350lm	10m	20m
AQS-500-65A12	6500K	24V DC	12W	350lm	10m	20m
AQS-500-GNA05	GREEN	24V DC	05W	80lm	15m	30m
AQS-500-BUA05	BLUE	24V DC	05W	14lm	15m	30m
AQS-500-RDA05	RED	24V DC	05W	44lm	15m	30m
AQS-500-ORA05	ORANGE	24V DC	05W	35lm	15m	30m
AQS-500-AMA05	AMBER	24V DC	05W	44lm	15m	30m
AQS-500-PKA05	PINK	24V DC	05W	60lm	15m	30m
AQS-500-22A05	2200K	24V DC	05W	120lm	15m	30m
AQS-500-25A05	2500K	24V DC	05W	120lm	15m	30m
AQS-500-27A05	2700K	24V DC	05W	120lm	15m	30m
AQS-500-30A05	3000K	24V DC	05W	120lm	15m	30m
AQS-500-35A05	3500K	24V DC	05W	130lm	15m	30m
AQS-500-40A05	4000K	24V DC	05W	130lm	15m	30m
AQS-500-50A05	5000K	24V DC	05W	140lm	15m	30m
AQS-500-57A05	5700K	24V DC	05W	140lm	15m	30m
AQS-500-65A05	6500K	24V DC	05W	140lm	15m	30m

Bending Directions

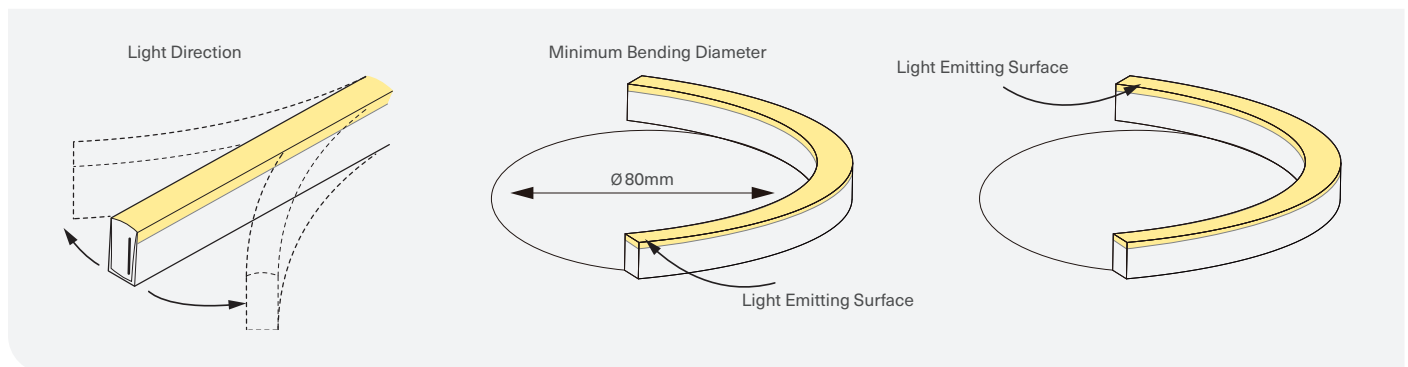

1300 662 644

sales@aqualux.com.au



Visit www.aqualux.com.au for: Full product details and available options. Order code configuration & customised datasheets. Voltage drop calculator & LED technical information.

Neon Flex

Extrusion and End Cap allowances

Assembly Notes

Direct Cable Output

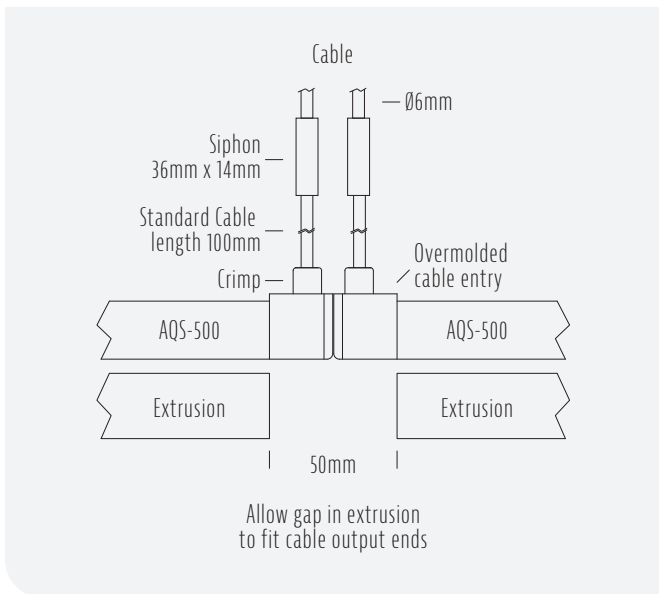

Direct Cable Output

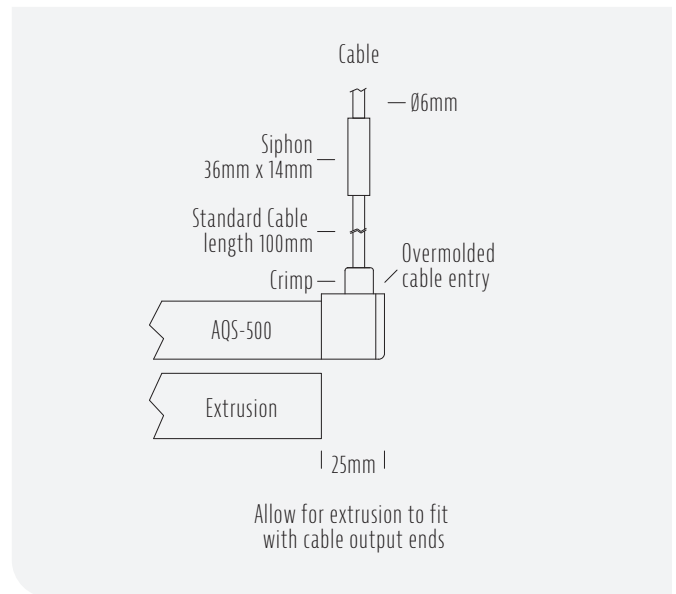

1300 662 644
sales@aqualux.com.au

Visit www.aqualux.com.au for: Full product details and available options.
Order code configuration & customised datasheets. Voltage drop calculator & LED technical information.

Anti-Siphon Cable Entry Options

- Integrated non-removeable anti-siphon device
- IP68 factory assembly only
- Injection Moulded Connectors

Direct Cable Entry

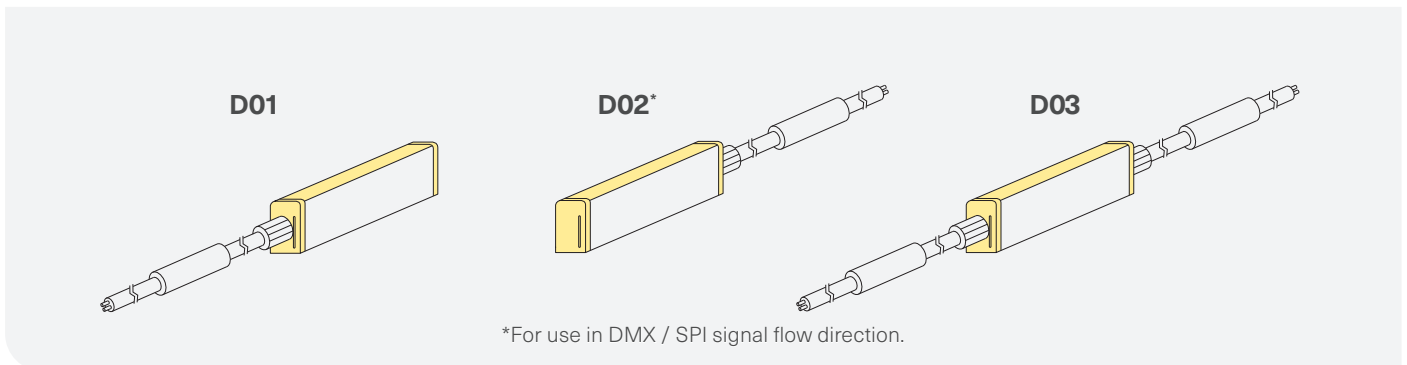

Side Cable Entry

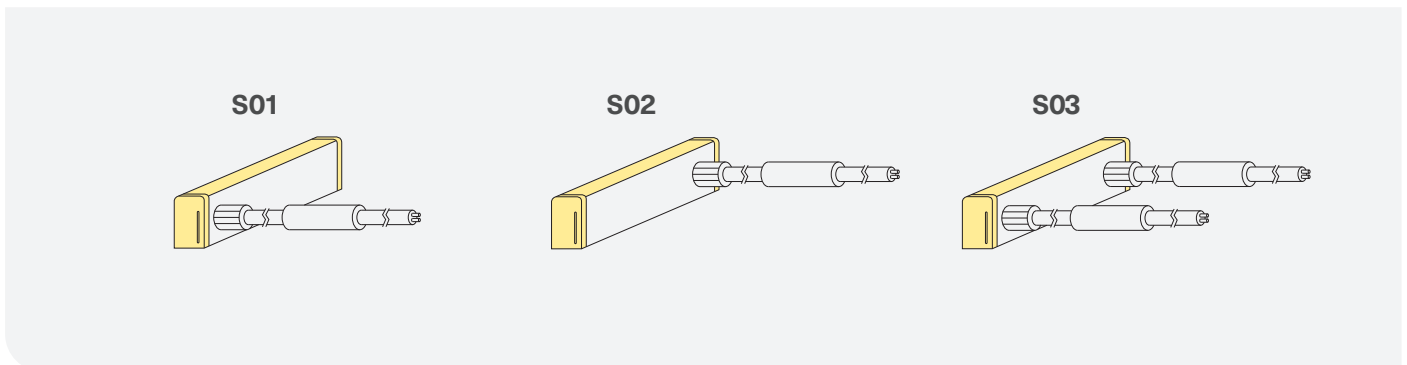

Bottom Cable Entry

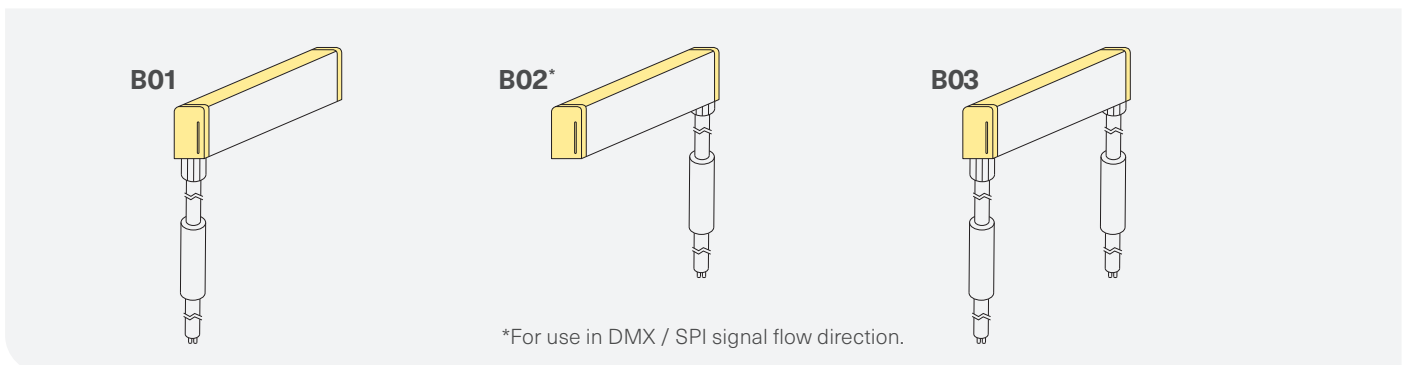

1300 662 644
sales@aqualux.com.au



Visit www.aqualux.com.au for: Full product details and available options. Order code configuration & customised datasheets. Voltage drop calculator & LED technical information.

Neon Flex

Injection Moulded Connectors Dimensions

Direct Cable Entry

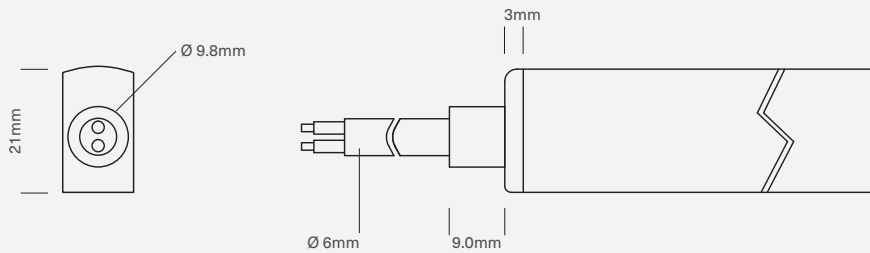

Side Cable Entry

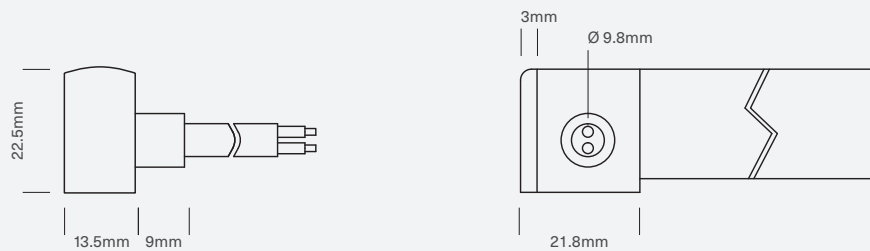

Bottom Cable Entry

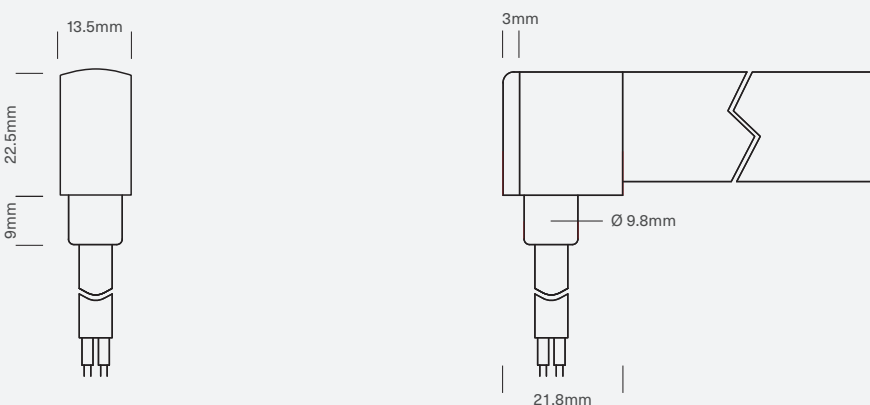

1300 662 644
sales@aqualux.com.au



Visit www.aqualux.com.au for: Full product details and available options.
 Order code configuration & customised datasheets. Voltage drop calculator & LED technical information.

Neon Flex

Charts and Diagrams

White Colour Chart

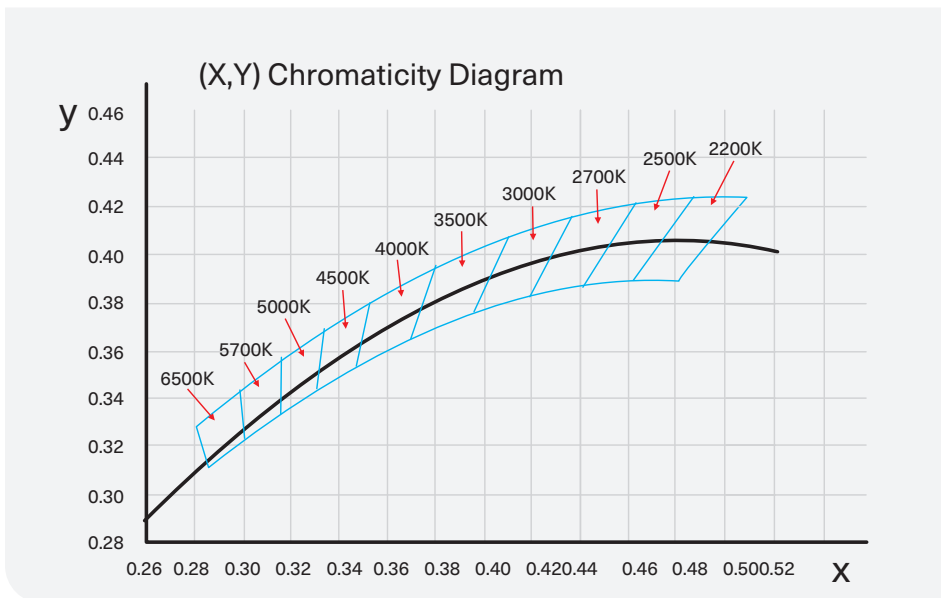

Mounting Channels

- AQS-500-ACC-01 = Clip
- AQS-500-ACC-AL-01 = 1m
- AQS-500-ACC-AL-02 = 2m

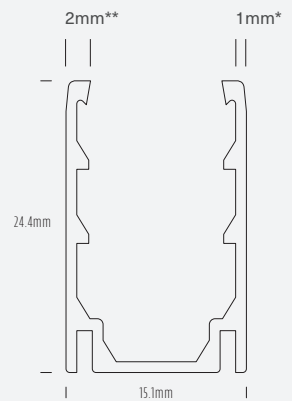

*1mm thick wall.
**2mm thick wall including grip.

Not stocked
Request order

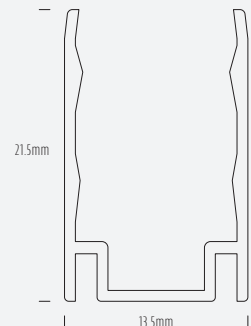

Photometric

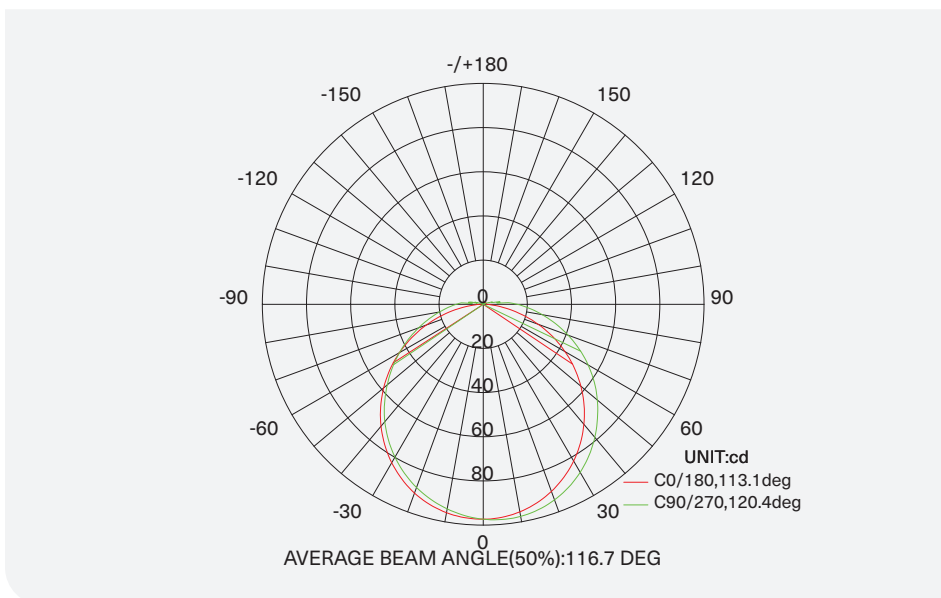

1300 662 644
sales@aqualux.com.au

Visit www.aqualux.com.au for: Full product details and available options.
Order code configuration & customised datasheets. Voltage drop calculator & LED technical information.

Neon Flex

AQS Family Reference Table

Product	Type	IP Rating	LED Options	Size mm	Power/m	Application
AQS-170	Cob Strip	IP20	Mono	10mm	10W DC	Internal / Profile required
AQS-260	Classic	IP65	Mono	10mm	12W AC / 15W DC	External / Profile required
AQS-400	Neon Flex	IP65	Mono	10 x 9	5W DC / 10W DC	External / No profile required
AQS-401	Neon Flex	IP65	Mono	10 x 10	10W DC	External / No profile required
AQS-410	Neon Flex	IP65	RGB	13 x 12	10W DC	External / No profile required
AQS-420	Neon Flex	IP65	Mono / RGBW	12 x 20	10W / 15W	External / No profile required
AQS-500	Neon Flex	IP68	Mono / RGB / RGBW / DMX	11.5 x 21	5W / 8W / 12W / 18W	External / Submerged / No profile
AQS-505	Neon Flex	IP68	Mono	13.5 x 13.5	10W	External / Submerged / No profile
AQS-510	Neon Flex	IP68	Mono / RGB / RGBW / DMX	16.5 x 16.5	10W / 13W / 17W / 18W	External / Submerged / No profile

Extension Wire Recommendations

Maximum extension wire length according to light power

Watts	22AWG 0.34mm ²	20AWG 0.53mm ²	18AWG 0.82mm ²	17AWG 1.04mm ²	16AWG 1.38mm ²	14AWG 2.07mm ²	12AWG 3.29mm ²	10AWG 5.62mm ²
10W	36m	60m	100m	120m	140m	240m	400m	600m
20W	18m	30m	50m	60m	70m	120m	200m	300m
30W	12m	20m	30m	38m	45m	80m	130m	200m
40W	8m	15m	22m	28m	35m	60m	95m	140m
50W	6m	12m	18m	22m	28m	48m	75m	105m
60W	5m	10m	15m	18m	22m	36m	60m	88m
70W	-	8m	12m	14m	18m	30m	50m	72m
80W	-	6m	10m	11m	14m	24m	40m	58m
90W	-	4m	7m	8m	10m	18m	30m	45m
100W	-	-	5m	6m	7m	12m	22m	32m
110W	-	-	3m	4m	5m	8m	15m	22m
120W	-	-	2m	2.5m	3m	0m	8m	12m



1300 662 644
sales@aqualux.com.au

Visit www.aqualux.com.au for: Full product details and available options.
Order code configuration & customised datasheets. Voltage drop calculator & LED technical information.