

Surface Mount Spot

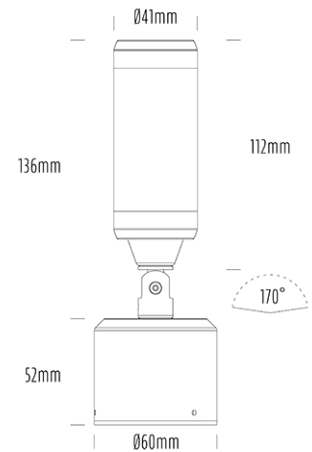

SPECIFICATIONS

Product Code	AQL-220
Family	Lumena
Construction Material	CNC Machined & Anodised Aluminium 6061
Cable	900mm Aqualux 2-Core Silicone / PTFE Cable
IP Rating	IP67
Warranty	5 Year Aqualux Warranty

CONFIGURED OPTIONS

Variant Code	AQL-220-A4X0043040Q
Body Colour	Dulux Venerable Silver 9067621K
Control Gear	12~24V AC / 24V DC
Rated Power	4W
Nominal Lumens	300 lm
CCT / Colour	3000K / 300mA
Optical	40
CRI	90
Other	AqualuxPLUS QuickConnect
Dimming	Optional 10V PWM (DC)

INTRODUCTION

Surface mount adjustable spot.



1300 662 644
sales@aqualux.com.au